

## DS-2DE5225W-AE(S6) 2 MP 25× Network Speed Dome



Hikvision DS-2DE5225W-AE(S6) 2 MP 25 × Network Speed Dome adopts 1/2.8" progressive scan CMOS chip. With the 25 × optical zoom lens, the camera offers more details over expansive areas.

This series of cameras can be widely used for wide ranges of high-definition, such as rivers, roads, railways, airports, squares, parks, scenic spots, and venues, etc.

- 1/2.8" Progressive Scan CMOS
- High quality imaging with 2 MP resolution
- Excellent low-light performance with powered-by-DarkFighter technology
- 25× optical zoom and 16× digital zoom provide close up views over expansive areas
- WDR, HLC, BLC, 3D DNR, defog, regional exposure, regional focus
- 24 VAC & PoE (802.3at)
- Efficient H.265+/H.265 compression technology



## ▪ DORI

The DORI (detect, observe, recognize, identify) distance gives the general idea of the camera ability to distinguish persons or objects within its field of view.

It is calculated based on the camera sensor specification and the criteria given by EN 62676-4: 2015.

DORI	Detect	Observe	Recognize	Identify
Definition	25 px/m	63 px/m	125 px/m	250 px/m
Distance (Tele)	1600.0 m (5249.3 ft)	634.9 m (2083.1 ft)	320.0 m (1049.9 ft)	160.0 m (524.9 ft)

## ▪ Specification

Camera Module	
Image Sensor	1/2.8" Progressive Scan CMOS
Min. Illumination	Color: 0.005 Lux @ (F1.6, AGC ON); B/W: 0.001 Lux @ (F1.6, AGC ON)
Shutter Speed	1 s to 1/30,000 s
Slow Shutter	Yes
Day & Night	IR cut filter
Zoom	25x optional, 16x digital
Max. Resolution	1920 × 1080
Lens	
Focus	Auto, semi-auto, manual
Focal Length	4.8 mm to 120 mm
Zoom Speed	Approx. 3.6 s
FOV	Horizontal field of view: 57.6° to 2.5° (wide-tele), Vertical field of view: 34.4° to 1.4° (wide-tele), Diagonal field of view: 64.5° to 2.9° (wide-tele)
Aperture	Max. F1.6
PTZ	
Movement Range (Pan)	360°
Movement Range (Tilt)	-5° to 90° (auto flip)
Pan Speed	Pan speed: configurable from 0.1° to 250°/s; preset speed: 300°/s
Tilt Speed	Tilt speed: configurable from 0.1° to 150°/s, preset speed 200°/s
Proportional Zoom	Yes
Presets	300
Patrol Scan	8 patrols, up to 32 presets for each patrol
Pattern Scan	4 pattern scans
Power-off Memory	Yes
Park Action	Preset, pattern scan, patrol scan, auto scan, tilt scan, random scan, frame scan, panorama scan
3D Positioning	Yes
PTZ Status Display	Yes
Preset Freezing	Yes
Scheduled Task	Preset, pattern scan, patrol scan, auto scan, tilt scan, random scan, frame scan, panorama scan, dome reboot, dome adjust, aux output

<b>Video</b>	
Main Stream	50 Hz: 25 fps (1920 × 1080, 1280 × 960, 1280 × 720) 60 Hz: 30 fps (1920 × 1080, 1280 × 960, 1280 × 720)
Sub-Stream	50 Hz: 25 fps (704 × 576, 640 × 480, 352 × 288) 60 Hz: 30 fps (704 × 480, 640 × 480, 352 × 240)
Third Stream	50 Hz: 25 fps (1920 × 1080, 1280 × 960, 1280 × 720, 704 × 576, 640 × 480, 352 × 288) 60 Hz: 30 fps (1920 × 1080, 1280 × 960, 1280 × 720, 704 × 480, 640 × 480, 352 × 240)
Video Compression	Main stream: H.265+/H.265/H.264+/H.264 Sub-stream: H.265/H.264/MJPEG Third stream: H.265/H.264/MJPEG
Video Bit Rate	32 Kbps to 16 Mbps
H.264 Type	Baseline profile/Main profile/High profile
H.265 Type	Main profile
Scalable Video Coding (SVC)	H.264 and H.265 encoding
Region of Interest (ROI)	8 fixed regions for each stream
<b>Audio</b>	
Audio Compression	G.711/G.722.1/G.726/MP2L2/PCM
Audio Bit Rate	64 Kbps (G.711)/16 Kbps (G.722.1)/16 Kbps (G.726)/32-192 Kbps (MP2L2)/32 Kbps (PCM)
Audio Sampling Rate	8 kHz/16 kHz/32 kHz/48 kHz
Environment Noise Filtering	yes
<b>Network</b>	
Network Storage	NAS (NFS, SMB/CIFS), auto network replenishment (ANR)
Protocols	IPv4/IPv6, HTTP, HTTPS, 802.1x, Qos, FTP, SMTP, UPnP, SNMP, DNS, DDNS, NTP, RTSP, RTCP, RTP, TCP/IP, UDP, IGMP, ICMP, DHCP, PPPoE, Bonjour, ISUP
API	Open Network Video Interface (Version 18.12, Profile S, Profile G, Profile T), ISAPI, SDK, ISUP
Simultaneous Live View	Up to 20 channels
User/Host	Up to 32 users; 3 user levels: administrator, operator, and user
Security	Password protection, complicated password, HTTPS encryption, 802.1X authentication (EAP-TLS, EAP-LEAP, EAP-MD5), watermark, IP address filter, basic and digest authentication for HTTP/HTTPS, control timeout settings, security audit log, TLS 1.2, host authentication (MAC address)
Client	iVMS-4200, HikCentral Pro, Hik-Connect
Web Browser	IE 10-11, Chrome 57+, Firefox 52+, Safari 12+
<b>Image</b>	
Day/Night Switch	Day, Night, Auto, Schedule
Image Enhancement	BLC, HLC, 3D DNR
Wide Dynamic Range (WDR)	120 dB
Defog	Digital Defog
Regional Exposure	Yes
Regional Focus	Yes
Image Settings	Saturation, brightness, contrast, sharpness, gain, and white balance adjustable by client software or web browser
Image Parameters Switch	Yes

Privacy Mask	24 programmable polygon privacy masks, mask color or mosaic configurable
SNR	> 52 dB
<b>Interface</b>	
Ethernet Interface	1 RJ45 10M/100M self-adaptive Ethernet port
On-board Storage	Built-in memory card slot, support microSD/SDHC/SDXC card, up to 256 GB
Alarm	2 inputs, 1 output
Audio	1 input (line in), max. input amplitude: 2-2.4 vpp, input impedance: 1 K $\Omega$ $\pm$ 10%; 1 output (line out), line level, output impedance: 600 $\Omega$
Reset	Yes
<b>Event</b>	
Smart Tracking	Manual tracking, auto-tracking
Basic Event	Motion detection, video tampering alarm, exception, alarm input and output
Smart Event	Face detection, line crossing detection, intrusion detection, region entrance detection, region exiting detection, unattended baggage detection, object removal detection, audio exception detection
Alarm Linkage	Upload to FTP/NAS/memory card, notify surveillance center, send email, trigger alarm output, trigger recording, and PTZ actions (such as preset, patrol scan, pattern scan)
<b>General</b>	
Operating Condition	-30 °C to 65 °C (-22 °F to 149 °F). Humidity 90% or less (non-condensing)
Power	24 VAC, Max. 20 W; PoE (802.3at)
Material	Metal
Dimensions	$\varnothing$ 220 mm $\times$ 280 mm ( $\varnothing$ 8.66" $\times$ 11.02")
Weight	Approx. 3.0 kg (6.61 lb.)
<b>Approval</b>	
Protection	IP66 (IEC 60529-2013), IK10, TVS 6000V lightning protection, surge protection and voltage transient protection

### ▪ Available Model

DS-2DE5225W-AE(S6)

▪ **Dimension**

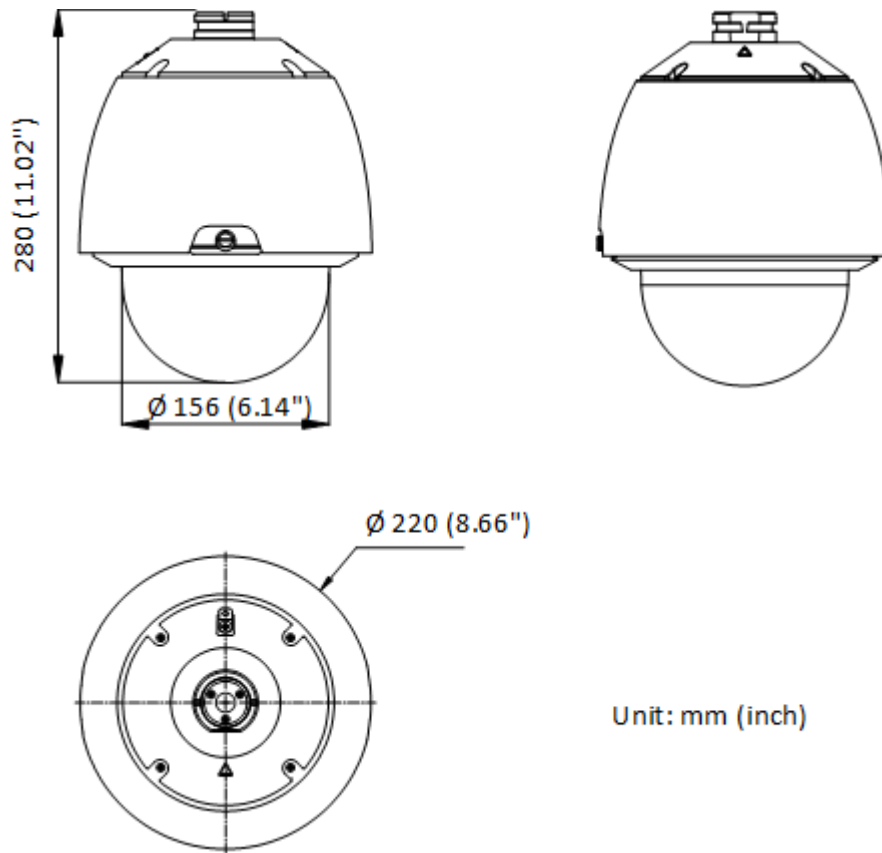

















▪ **Accessory**

▪ **Included**

**DS-1602ZJ**



▪ Optional

<b>DS-1604ZJ-pole</b>	<b>DS-1604ZJ-BOX-POLE</b>	<b>DS-1663ZJ</b>	<b>DS-1619ZJ</b>	<b>DS-1660ZJ</b>
				
<b>DS-1604ZJ-box</b>	<b>DS-1662ZJ</b>	<b>DS-1100KI</b>	<b>DS-1661ZJ</b>	<b>DS-1005KI</b>
				
<b>DS-1673ZJ</b>	<b>DS-1682ZJ</b>	<b>DS-1604ZJ-BOX-CORNER</b>	<b>DS-1604ZJ-corner</b>	<b>DS-1604ZJ</b>
				
<b>DS-1681ZJ</b>	<b>DS-1667ZJ</b>			
				

\*DS-1673ZJ should be used with DS-1661ZJ or DS-1602ZJ.

Distributed by

**HIKVISION®****Headquarters**

No.555 Qianmo Road, Binjiang District,  
Hangzhou 310051, China  
T +86-571-8807-5998  
overseasbusiness@hikvision.com

**Hikvision USA**  
T +1-909-895-0400  
sales.usa@hikvision.com

**Hikvision Australia**  
T +61-2-8599-4233  
salesau@hikvision.com

**Hikvision India**  
T +91-22-28469900  
sales@pramahikvision.com

**Hikvision Canada**  
T +1-866-200-6690  
sales.canada@hikvision.com

**Hikvision Thailand**  
T +662-275-9949  
sales.thailand@hikvision.com

**Hikvision Europe**  
T +31-23-5542770  
sales.eu@hikvision.com

**Hikvision Italy**  
T +39-0438-6902  
info.it@hikvision.com

**Hikvision Brazil**  
T +55 11 3318-0050  
Latam.support@hikvision.com

**Hikvision Turkey**  
T +90 [216]521 7070- 7074  
sales.tr@hikvision.com

**Hikvision Malaysia**  
T +601-7652-2413  
sales.my@hikvision.com

**Hikvision UK & Ireland**  
T +01628-902140  
sales.uk@hikvision.com

**Hikvision South Africa**  
Tel: +27 (10) 0351172  
sale.africa@hikvision.com

**Hikvision France**  
T +33(0)1-85-330-450  
info.fr@hikvision.com

**Hikvision Kazakhstan**  
T +7-727-9730667  
nikia.panfilov@hikvision.ru

**Hikvision Vietnam**  
T +84-974270888  
sales.vt@hikvision.com

**Hikvision UAE**  
T +971-4-4432090  
salesme@hikvision.com

**Hikvision Singapore**  
T +65-6684-4718  
sg@hikvision.com

**Hikvision Spain**  
T +34-91-737-16-55  
info.es@hikvision.com

**Hikvision Tashkent**  
T +99-87-1238-9438  
uzb@hikvision.ru

**Hikvision Hong Kong**  
T +852-2151-1761  
info.hk@hikvision.com

**Hikvision Russia**  
T +7-495-669-67-99  
saleru@hikvision.com

**Hikvision Korea**  
T +82-(0)31-731-8817  
sales.korea@hikvision.com

**Hikvision Poland**  
T +48-22-460-01-50  
info.pl@hikvision.com

**Hikvision Indonesia**  
T +62-21-2933759  
Sales.Indonesia@hikvision.com

**Hikvision Colombia**  
sales.colombia@hikvision.com